

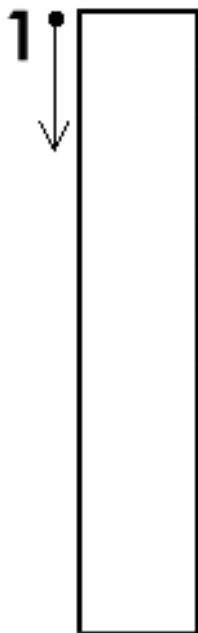

From *Gilead® Success with Phonics*
© J. Jeanne Wherrett, 2004-2009, 2013, Gilead Enterprises

Illustrations:
igloo – © C. French



Rainbow Letters

Book 1

l, t, i, j, k

Always “top to bottom”.



long

legs

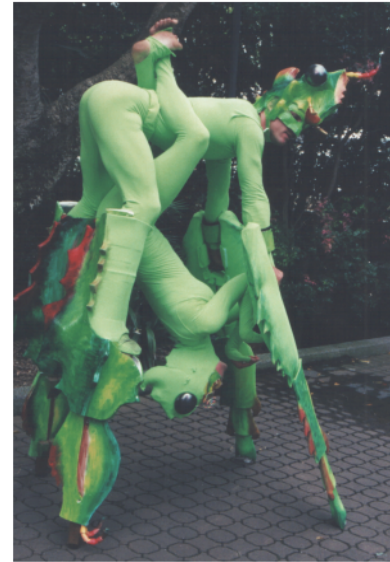

“Top to bottom.”

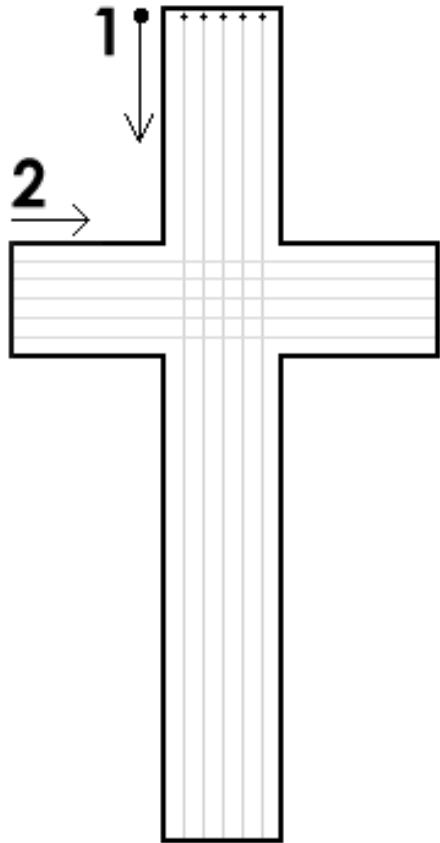

“Down, across.”

eating

those

toes



inside an

igloo

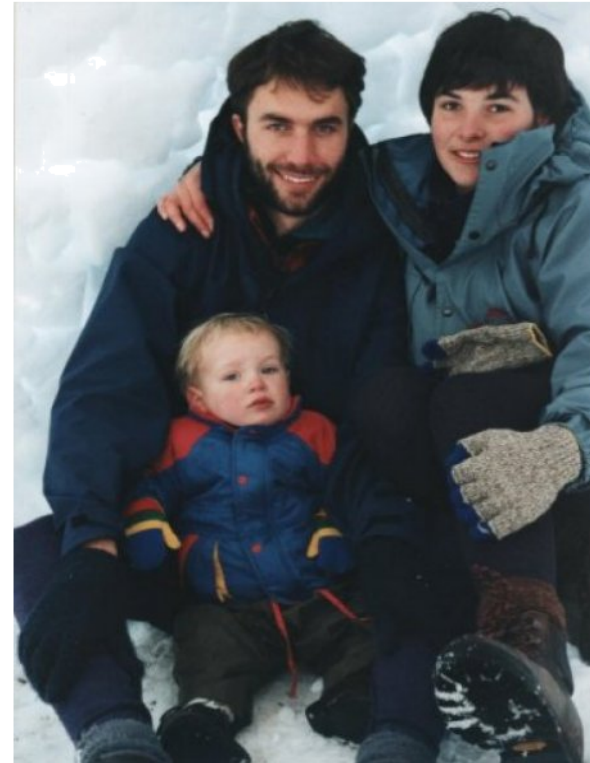

“Top to bottom, then the dot.”

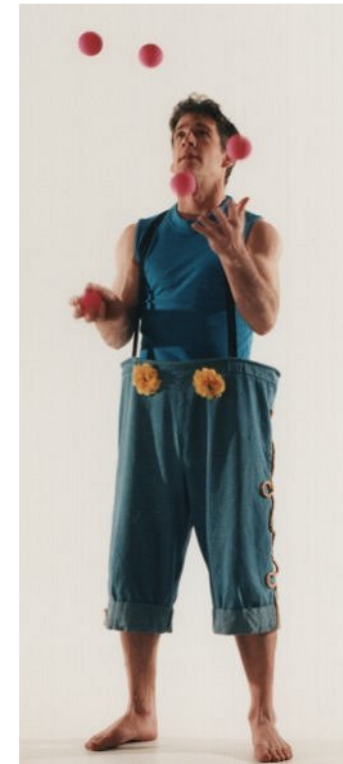
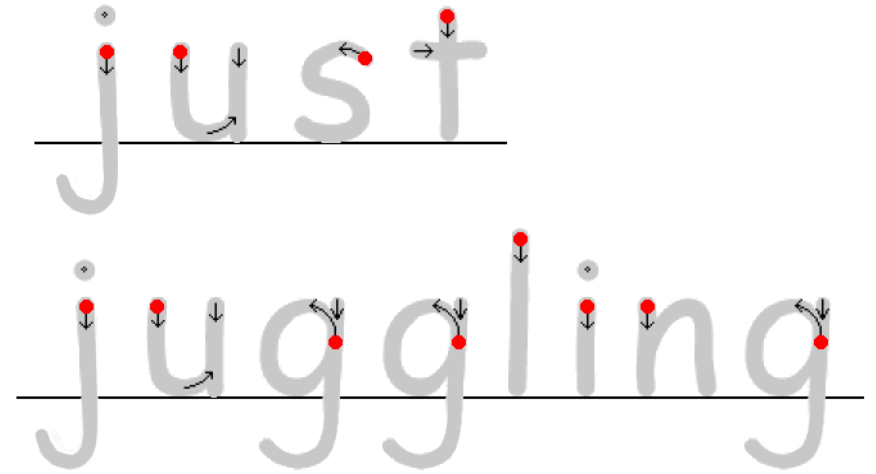
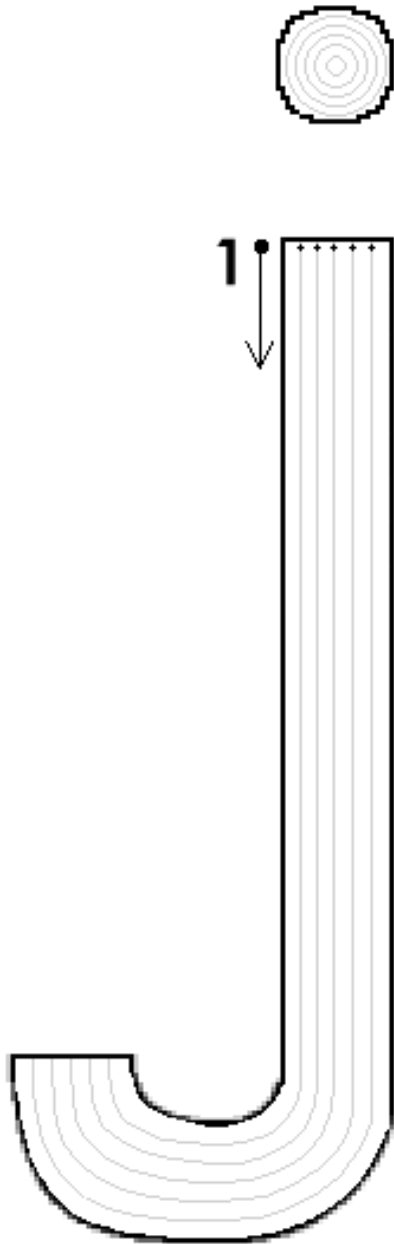

“Down and round, and then the dot.”

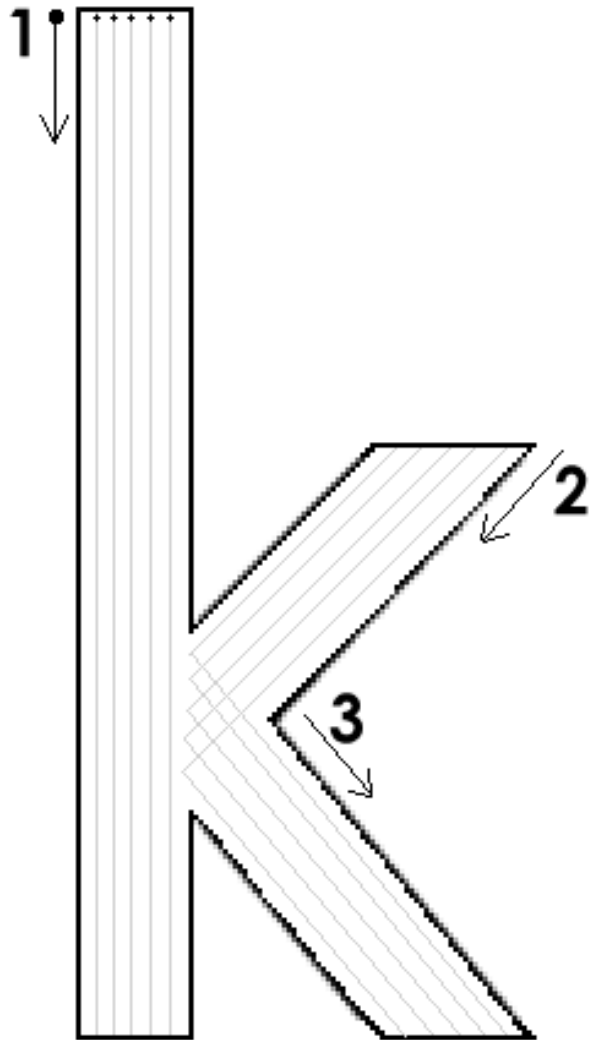

The kid
can kick.



“Down, down, down.”